

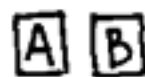

TOY PIANO.



TOY XYLOPHONE.



PLAY "A", THEN PLAY "B".

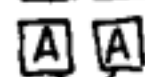

"A" LASTS LONGER.



USE ANYWHERE FROM x TO y NOTES. IN $\overset{xny}{\boxed{A}}-\overset{xny}{\boxed{A}}$ IS THE MAXIMUM TOTAL NUMBER OF NOTES, NOT THE MAXIMUM FOR EACH BOX.



PLAY "A" AND "B" SIMULTANEOUSLY.



SYNCHRONIZE SOME ASPECT(S) OF "A" AND "B",  AVOID SYNCHRONIZATION

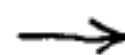

SPEED UP. INTENSITY INDICATED BY THE NUMBER OF ARROWHEADS.



SLOW DOWN. INTENSITY AS ABOVE.



TEMPO RESET, BACK TO NORMAL



VERY HIGH NOTE(S). IF THERE IS MORE THAN ONE, EACH MUST BE ALLOWED TO END COMPLETELY.



MELODY. LEGATO, NO WIDE JUMPS, SLOW TRIPLETS.





MELODY ARC ,  THE SAME, REVERSED.



SEQUENCE OF FOURTH-CONNECTED PITCHES, E.G. C5 - F5 - C5 - C4 - Bb5 - ...

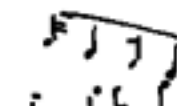

COLLAPSE ,  THE SAME, REVERSED.

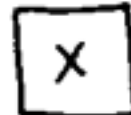

A NOISE (HIT THE INSTRUMENT, USE EXTRA PERCUSSION, ETC.)

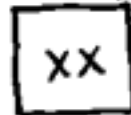

TWO NOISES (SEE ABOVE) IN QUICK SUCCESSION

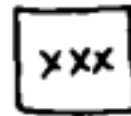

MANY NOISES IN QUICK SUCCESSION, OR CONTINUOUS NOISE



SAME AS ABOVE, BUT WITH A REGULAR RHYTHM AND NOT NECESSARILY FAST



TONELESS GLISSANDO (KNUCKLES, FINGERNAILS, ETC. OVER THE KEYS W/O PRESSING OR HITTING ANY)





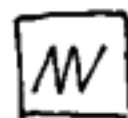
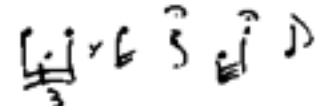

VERY WIDE INTERVALS (HIGH NOTE + LOW NOTE, TWO ONLY)

 ENTITY BREAKUP. E. G. A CHORD FOLLOWED BY FRAGMENTS OF THE SAME CHORD, FOLLOWED BY SINGLE NOTES, SLOWING DOWN; OR REPLACE "CHORD" WITH "MELODY", "ARPEGGIO", ETC.

 ENTITY ASSEMBLY. SAME AS ABOVE, REVERSED.

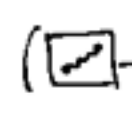
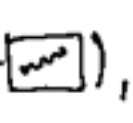
 TREMOLO WITH BREAKS, E. G.  ETC. SAME NOTE THROUGHOUT A LEVEL.

 GLISSANDO, UP;  DOWN. IF LONG (-), GOES UP, AND DOWN, AND UP, ETC.

 MELODY X. "EXP" INDICATES AUGMENTATION WITH ORNAMENTATION,
"RED" INDICATES ONE SHOULD IGNORE NOTES UNAVAILABLE ON THE INSTRUMENT USED,
"SM" INDICATES COMPRESSION INTO A FEW CHORDS AND GRACE NOTES.

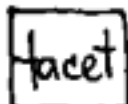
 SILENCE.

 ANY OF THE ABOVE, PERFORMER'S CHOICE.

 METALLIC, HARSH PERCUSSION HIT

 DULL PERCUSSION HIT

 EITHER OF THE PERCUSSIVE SOUNDS ABOVE

LEVEL 1

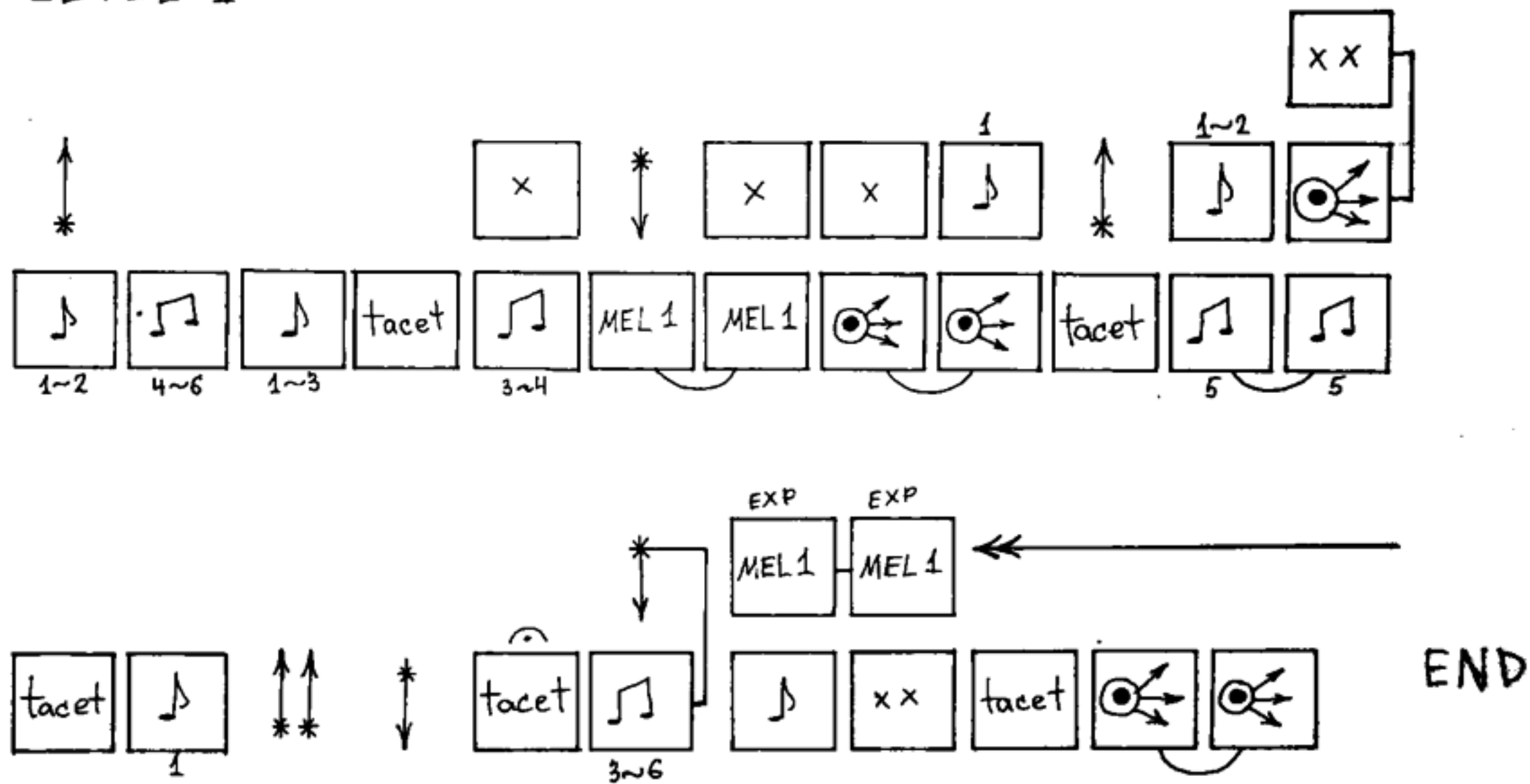

LEVEL 2

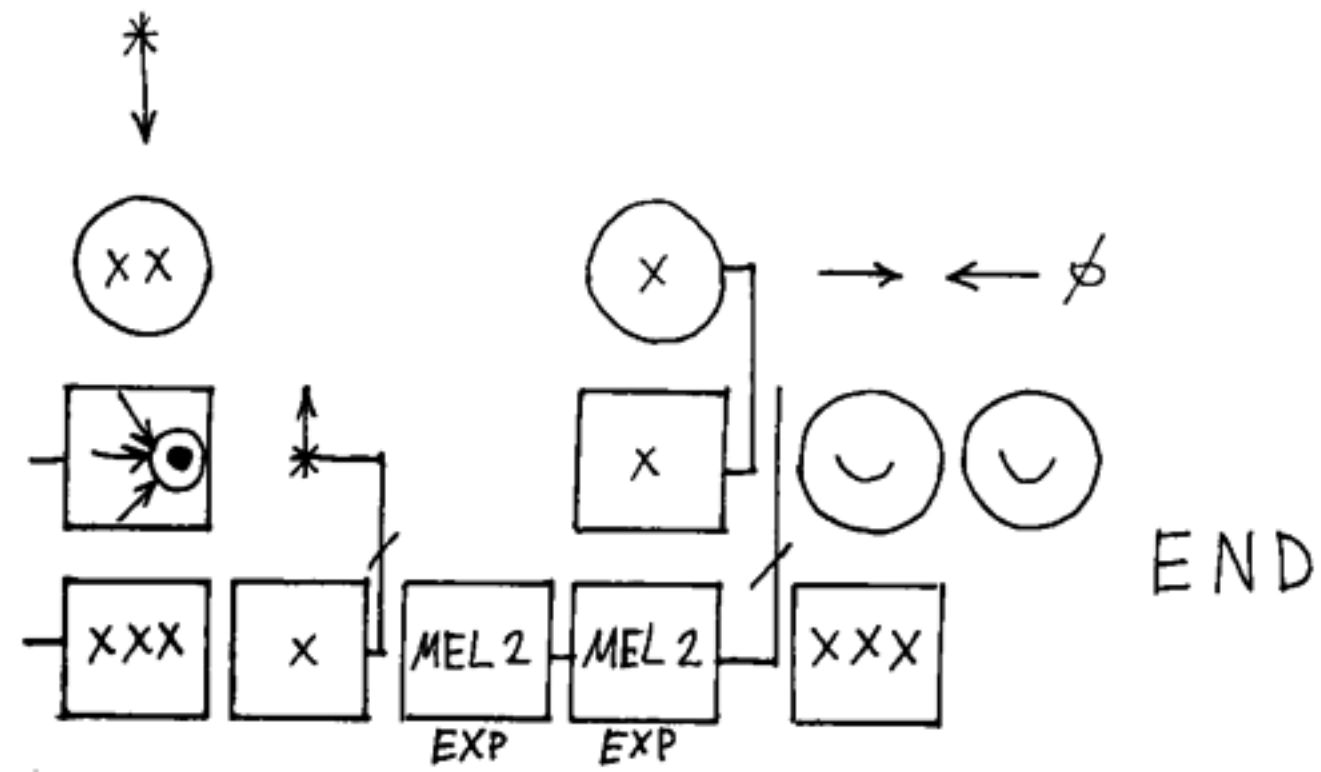
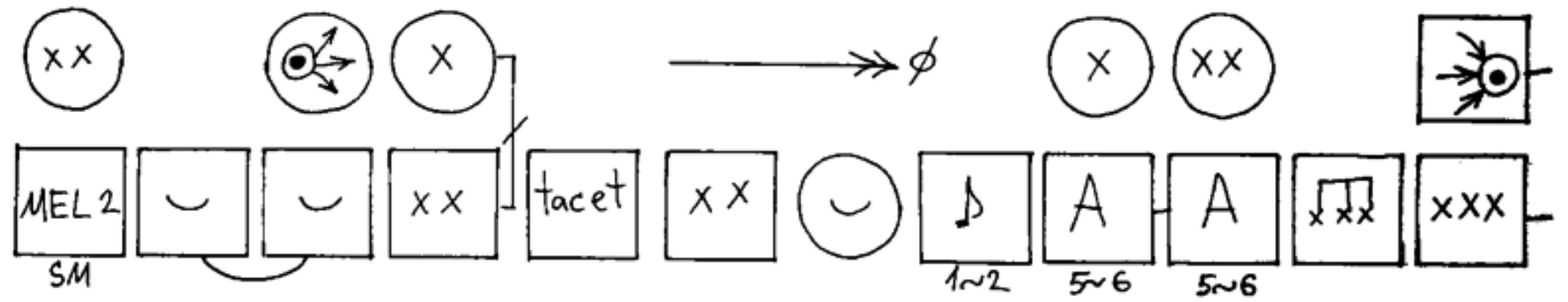
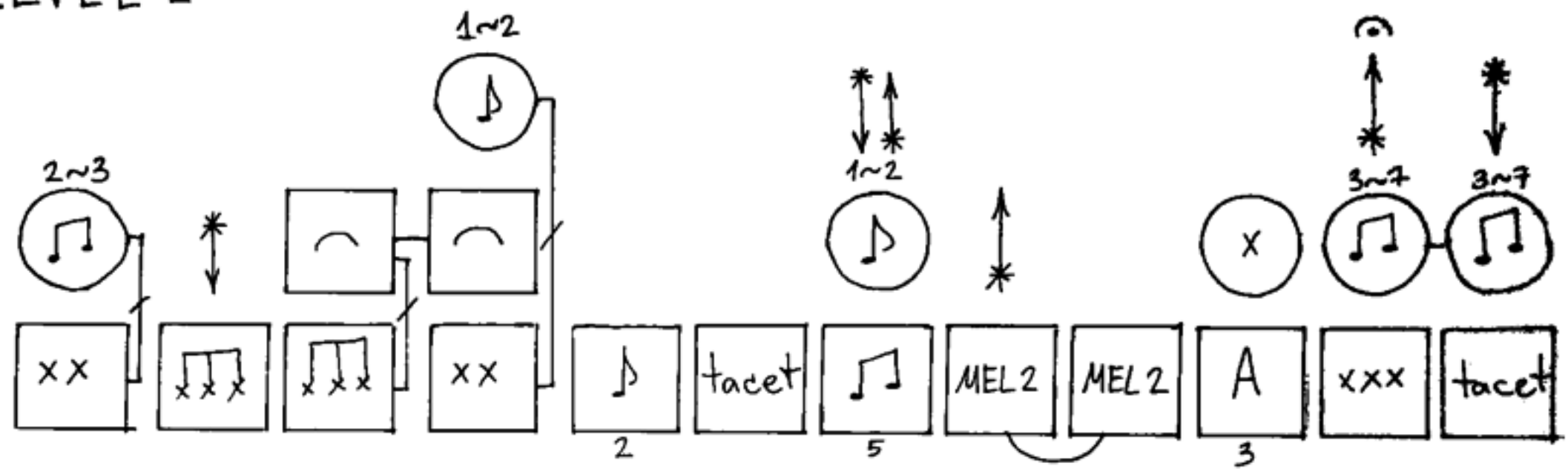

LEVEL 3

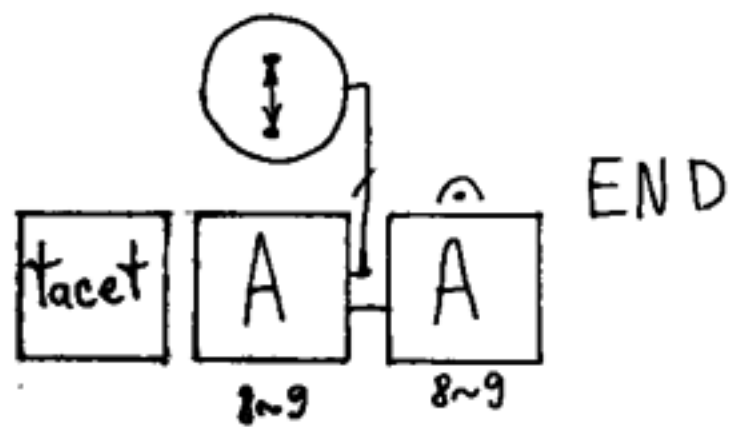
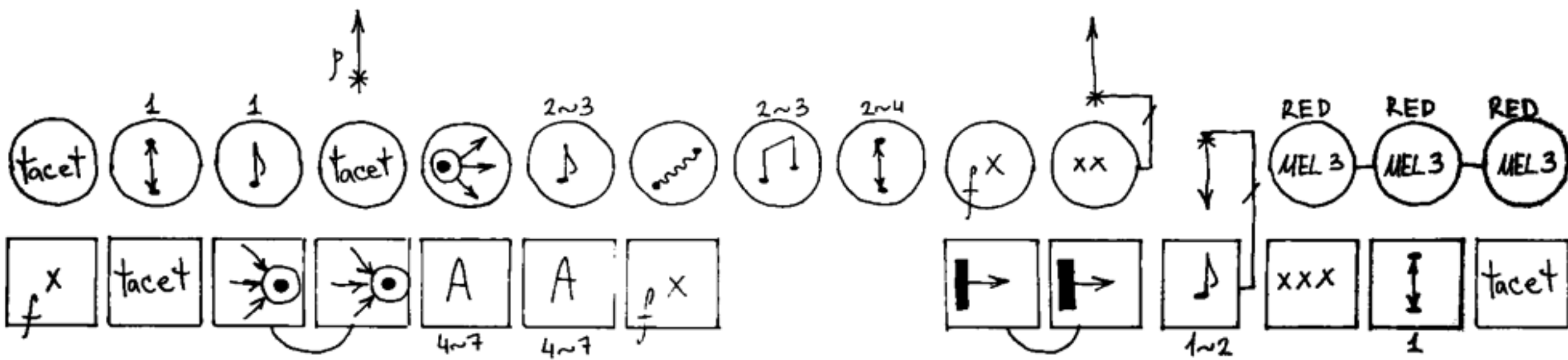
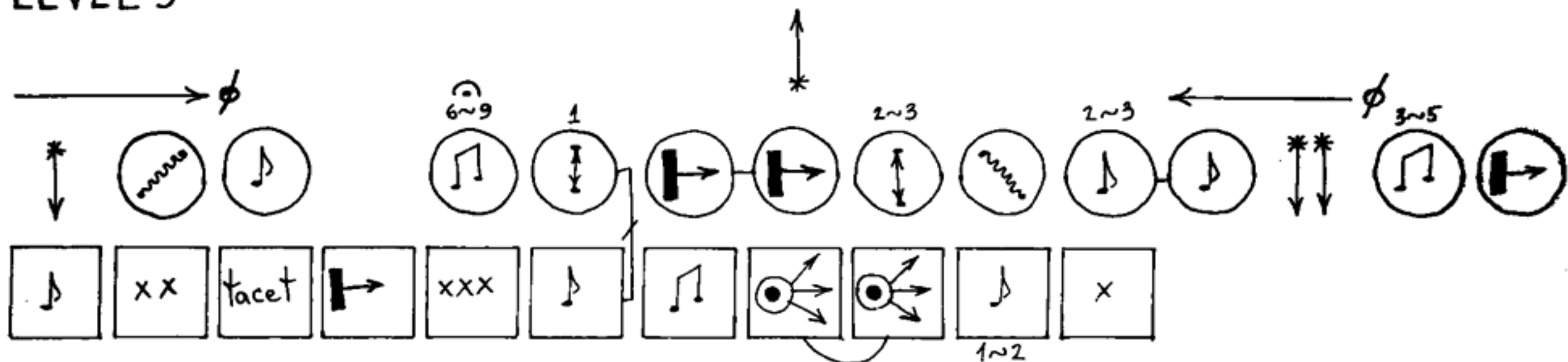

LEVEL 6

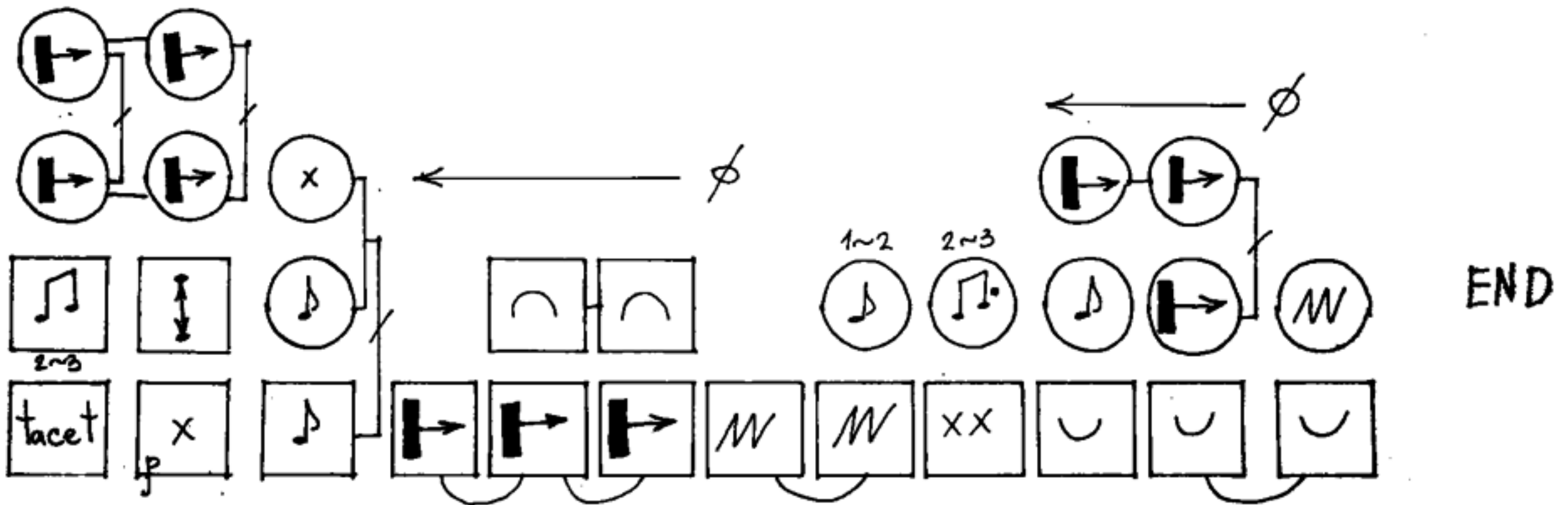
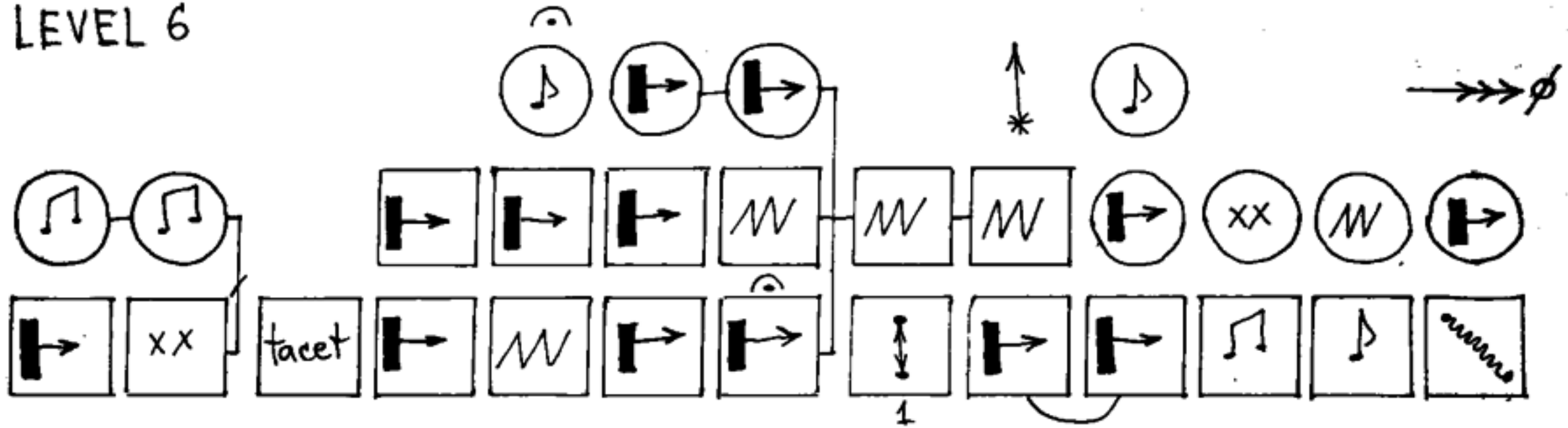

LEVEL 7

